



[www.binq.com.au](http://www.binq.com.au)  
[info@binq.com.au](mailto:info@binq.com.au)  
03 9773 2373  
2-4 Ashley Park Drive,  
Chelsea Heights 3196



## Maintaining your timber windows

**To ensure that your timber doors and windows are operating and looking brand new, we recommend that occasionally, you are taking a look and giving them a bit of care.**

Depending on the location of your doors and windows within certain sites, some may be at more risk of weather-related issues than others. To ensure your timber remains healthy, we recommend washing down your doors and windows with warm, soapy water. Different climates and locations require more frequent attention than others due to natural circumstances that may surround you. Below are common locations that we regularly see and how often we recommend you take action.

**Beach Front** - Every 3 months

**Coastal** - Every 6 months

**Standard** - Every 12 months

### **Finished Windows:**

For finishes, we recommend giving them a thorough rinse down with warm, soapy water when appropriate.

For stained finishes, we recommend re-coating them every 4-5 years

To re-coat effectively, wash units with warm, soapy water.

Once dry, give them a light sand, taking off a THIN layer of stain

Once sanding is finished, remove all remaining dust left over by blowing air thoroughly across all affected areas

Apply desired stain using a soft bristle brush to any areas that need to be re-coated.

Apply the stain to ensure that the affected areas match the rest of the product and let dry for 12 hours

Once dry, apply top coat with a soft bristle brush (1 coat) and allow to dry for 12 hours

## Maintaining your timber windows

### Things to remember

Timber products that are in the direct sunlight without any cover or eave for protection are more prone to being damaged over time than those that are.

Once you begin your process of re-staining or re applying paint to your doors/windows, it is important to NOT leave any part of the product unprotected with out stain or paint for extended periods of time.

If you experience violent weather, we recommend (once it is safe to do so), to assess any debris or other factors that may have caused damage to your doors/windows.

If you have any sliding doors or windows, every once in a while, check the bottom tracks on the sills to ensure there is no dust or debris that may damage the mechanisms of your operable sashes/panels.

If timber is not properly coated, it is more prone to bowing and warping as opposed to something that is stained or painted.

If using an oil based product, ALWAYS check with your coating supplier if it is safe to use on our products.

Some oil-based products are known to corrode the silicon that is used stabilize and protect the glass within your doors/windows.

When maintaining your doors and windows, it is always important to use the most appropriate safety measures when possible. (E.g., wearing a mask when sanding, covering skin when using certain coating products, having the correct equipment for hard-to-reach areas.)

It is also important to remember that some tasks are a lot easier with a helping hand. At BINQ, your safety is just as important as our own. Always seek assistance if a task is too strenuous or may cause risk to your own health or those around you.

If you require more information or assistance, please do not hesitate to contact our friendly staff in our head office.



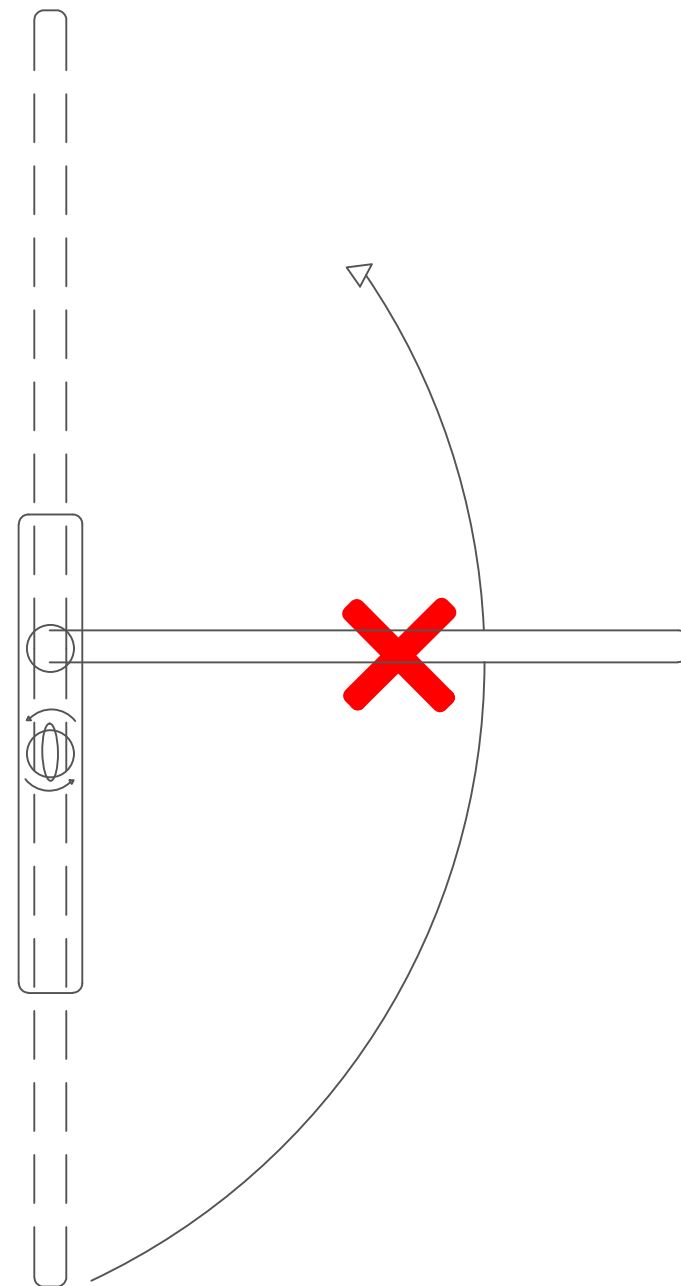
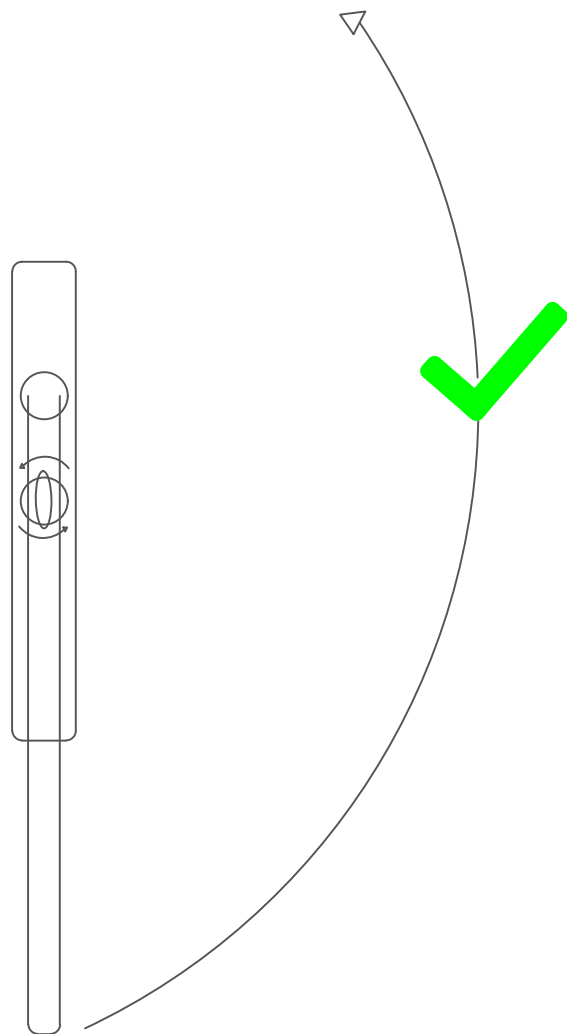
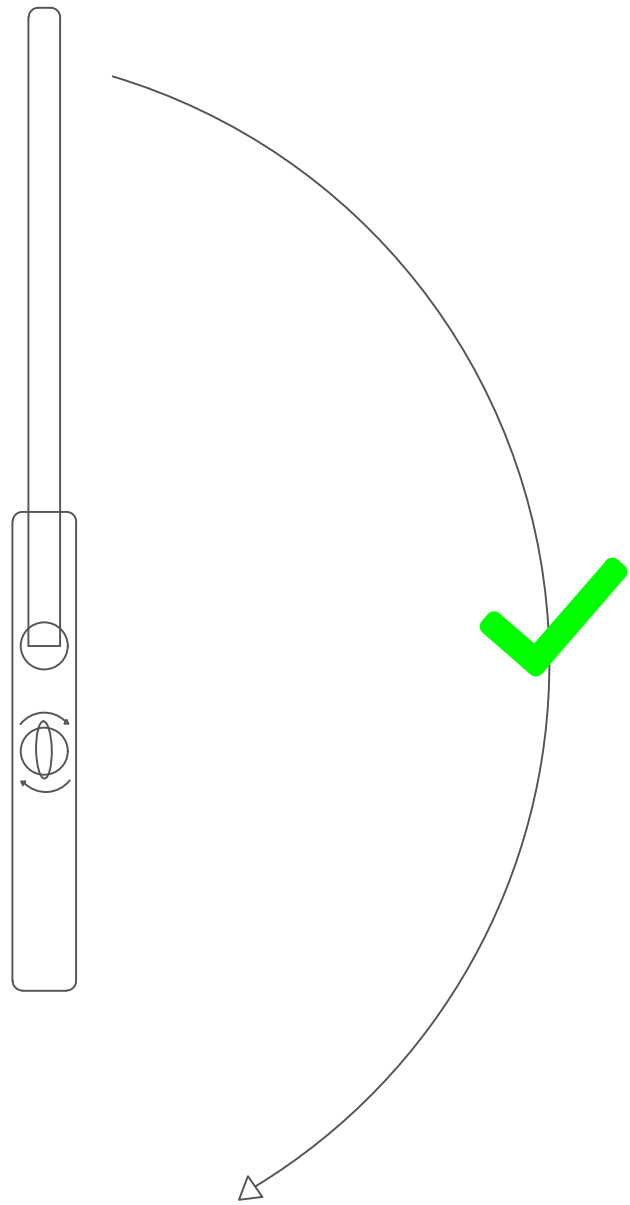

**HOW TO LOCK:**

1. Once operable panel is in the closed position, rotate handle 180 degrees UPWARDS to drop panel onto the track to stop lateral movement.
2. Once the handle has been rotated, turn the snib (or key) 180 degrees to lock panel in place.
3. ALWAYS check that the door is securely locked by ensuring the handle can not be rotated downward.



**HOW TO UNLOCK:**

1. Turn the snib (or key) 180 degrees to unlock and enable handle to be rotated.
2. Rotate handle DOWNWARDS 180 degrees to lift operable panel off the track to allow the panel to slide open.

**PLEASE NOTE:**

If you have the KEY option, ensure key is removed after operation to avoid collision with handle (resulting in possible scratches).

Do NOT slide the door with handle in 90 degree position

<b>Lift &amp; Slide Handle Operation</b>			REV
PART NO. VARIOUS	PROJECT		A
DRAWN BY/DATE BG 6/10/22	REFERENCE	www.binq.com.au	SHEET 1 / 1
MATERIAL VARIES	 SCALE @ A3 DNS	WEIGHT 1	<small>THIS DRAWING IS THE PROPERTY OF BINQ. Information contained herein is confidential and is not to be used or disclosed to third parties without the written consent of binq.</small>
FINISH/TREATMENT	$X \pm 0.1$ $XX \pm 0.01$ $\pm 0.25'$		

### Engaging Multi Point Lock

1. Rotate lever handle 45 degrees upwards to engage multi-point lock

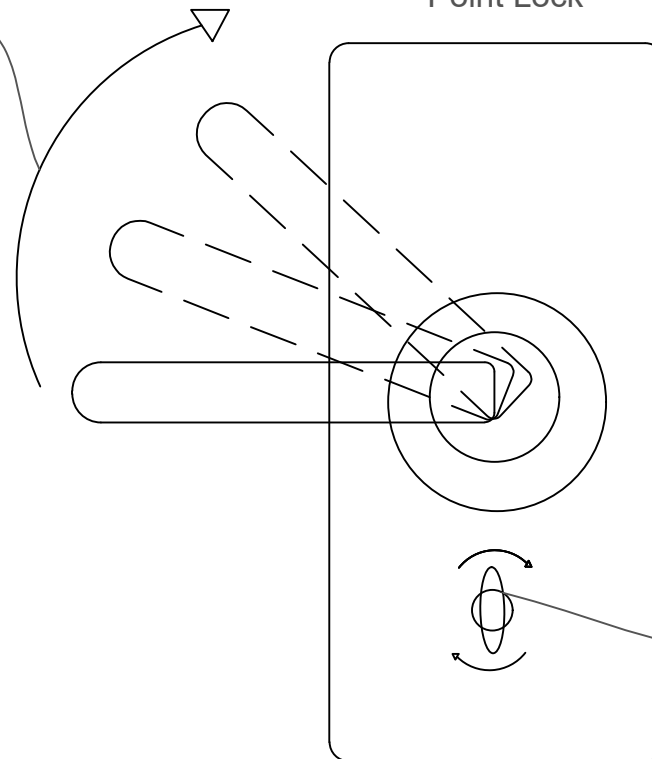

2. Rotate snib/key clockwise 180 degrees to secure locks

#### HOW TO LOCK:

1. Rotate handle 45 degrees UPWARDS to eject and engage the multiple locking hooks (hooks are tapered and will pull the sash tight against the seals). Some moderate force may be required.
2. Once hooks are engaged, turn the key (or snib) 180 degrees clockwise (viewed from inside). This will lock secure the hooks in position.
3. ALWAYS check that the door is securely locked by ensuring the handle can not be rotated downward to disengage locking hooks.

#### HOW TO UNLOCK:

1. Turn the key (or snib) anti-clockwise 180 degrees (viewed from inside).
2. Rotate handle downwards 45 degrees to retract the hooks and latch allowing the door to open.

### Disengaging Multi Point Lock

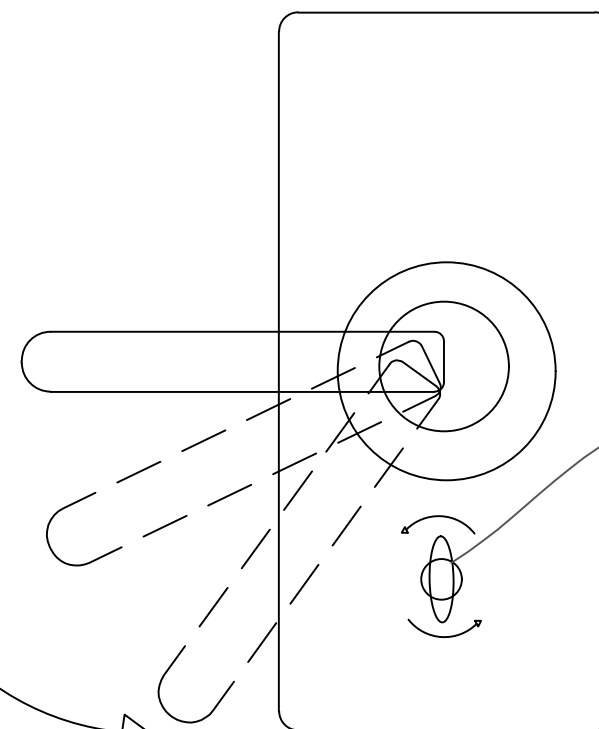

1. Rotate snib/key anti clockwise 180 degrees to release hooks

2. Rotate lever handle 45 degrees downwards to disengage locking hooks

#### PLEASE NOTE:

The key (or snib) cannot be rotated 180 degrees to securely lock the door without fully engaging the multi-point locks (i.e. by lifting the handle 45 degrees upward)

BINQ recommends that the multi-point lock are always engaged to ensure an airtight seal and to prevent the door from bowing.

Multi-point Lock Instructions			
PART NO. VARIOUS	PROJECT		
DRAWN BY/DATE BG 09/08/2022	REFERENCE		
MATERIAL VARIES	SCALE @ A3 DNS	www.binq.com.au	REV
FINISH/TREATMENT	WEIGHT 1	THIS DRAWING IS THE PROPERTY OF BINQ PTY LTD. INFORMATION CONTAINED HEREIN IS CONFIDENTIAL AND IT IS NOT TO BE USED NOR DISCLOSED TO 3RD PARTIES WITHOUT OUR WRITTEN PERMISSION	SHEET 1 / 1 A



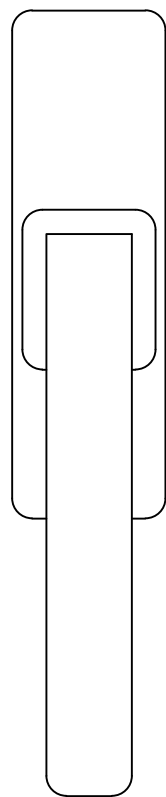

A

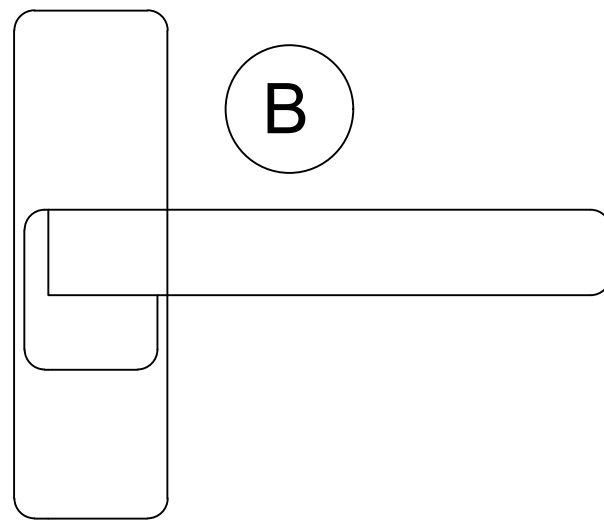

B

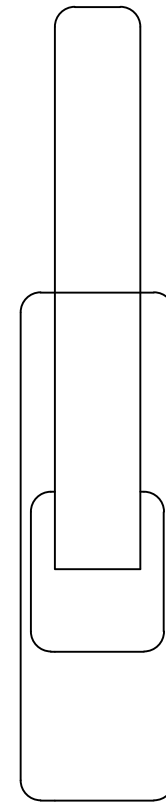

C

**LOCKED**

For sash to be securely locked, the handle must be in position (a). This ensures all strikers are engaged.

**TURN:**

From position (a), rotate handle 90 degrees UPWARDS into position (b) to open sash into dwelling (for cleaning and maintenance).

**TILT**

From position (b), rotate handle 90 degrees UPWARDS into position (c) to tilt sash into dwelling (for secure and efficient ventilation).

**PLEASE NOTE:**

Do NOT add any unnecessary weight onto the sash.

Do NOT insert any objects between the sash and the frame of the window.

Do NOT leave your sash in the turn position if you are experiencing high winds.

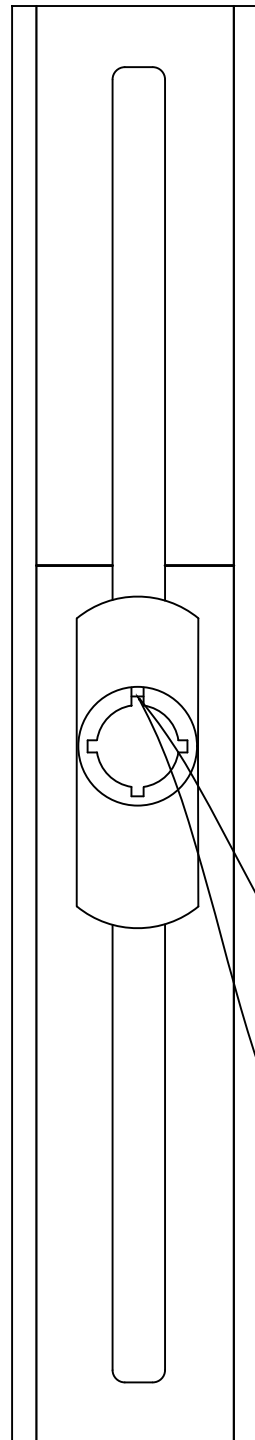

Tilt & Turn Handle Operation			www.binq.com.au	REV A
PART NO. VARIOUS	PROJECT			
DRAWN BY/DATE BG 6/10/22	REFERENCE	<small>THIS DRAWING IS THE PROPERTY OF BINQ. Information contained herein is confidential and is not to be used or disclosed to third parties without the written consent of binq.</small>		
MATERIAL VARIES	SCALE @ A3 DNS			
FINISH/TREATMENT	WEIGHT 1	SHEET 1 / 1		

If you feel that your Tilt & Turn handle has become difficult to operate or your sash is not sealing properly once closed, it is recommended that you adjust your sash locks using the instructions below



To weaken seal compression, using 4mm allen key, the top most slit on turning mechanism must face the outside of your window

To strengthen seal compression, using 4mm allen key, the top most slit on turning mechanism must face the inside of your window

TT Sash Lock Adjustment				REV	
PART NO. VARIOUS	PROJECT			www.binq.com.au	
DRAWN BY/DATE BG 7/12/2022	REFERENCE				
MATERIAL VARIES		SCALE @ A3 DNS	THIS DRAWING IS THE PROPERTY OF BINQ. Information contained herein is confidential and is not to be used or disclosed to third parties without the written consent of binq		
FINISH/TREATMENT	$X \pm 0.1$ $\times X \pm 0.01$ $\pm 0.25'$	WEIGHT 1	SHEET 1 / 1		A

via sash stay

Lateral adjustment

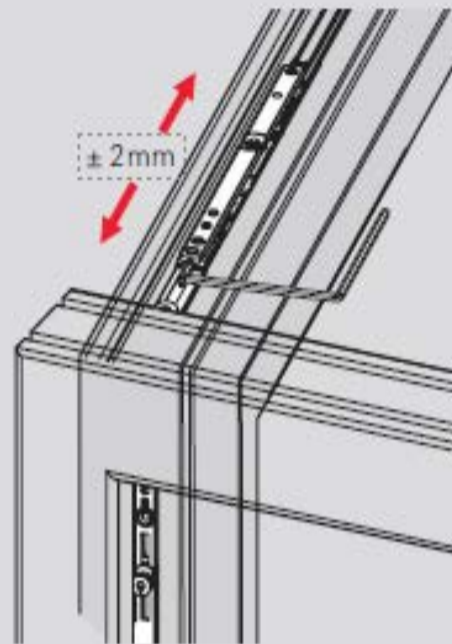

Gasket-compression adjustment



via pivot rest / corner hinge

Height adjustment

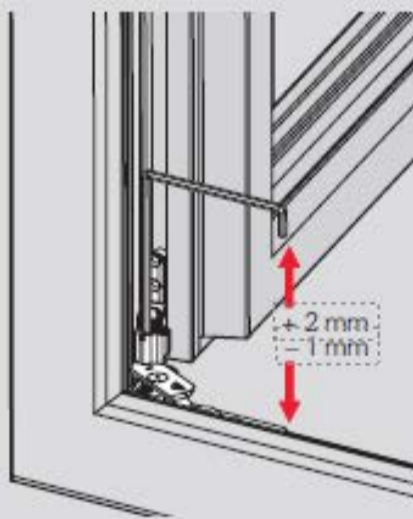

Lateral adjustment



Gasket-compression adjustment



After the height adjustment, the load transfer device has to be readjusted (refer to page 51).



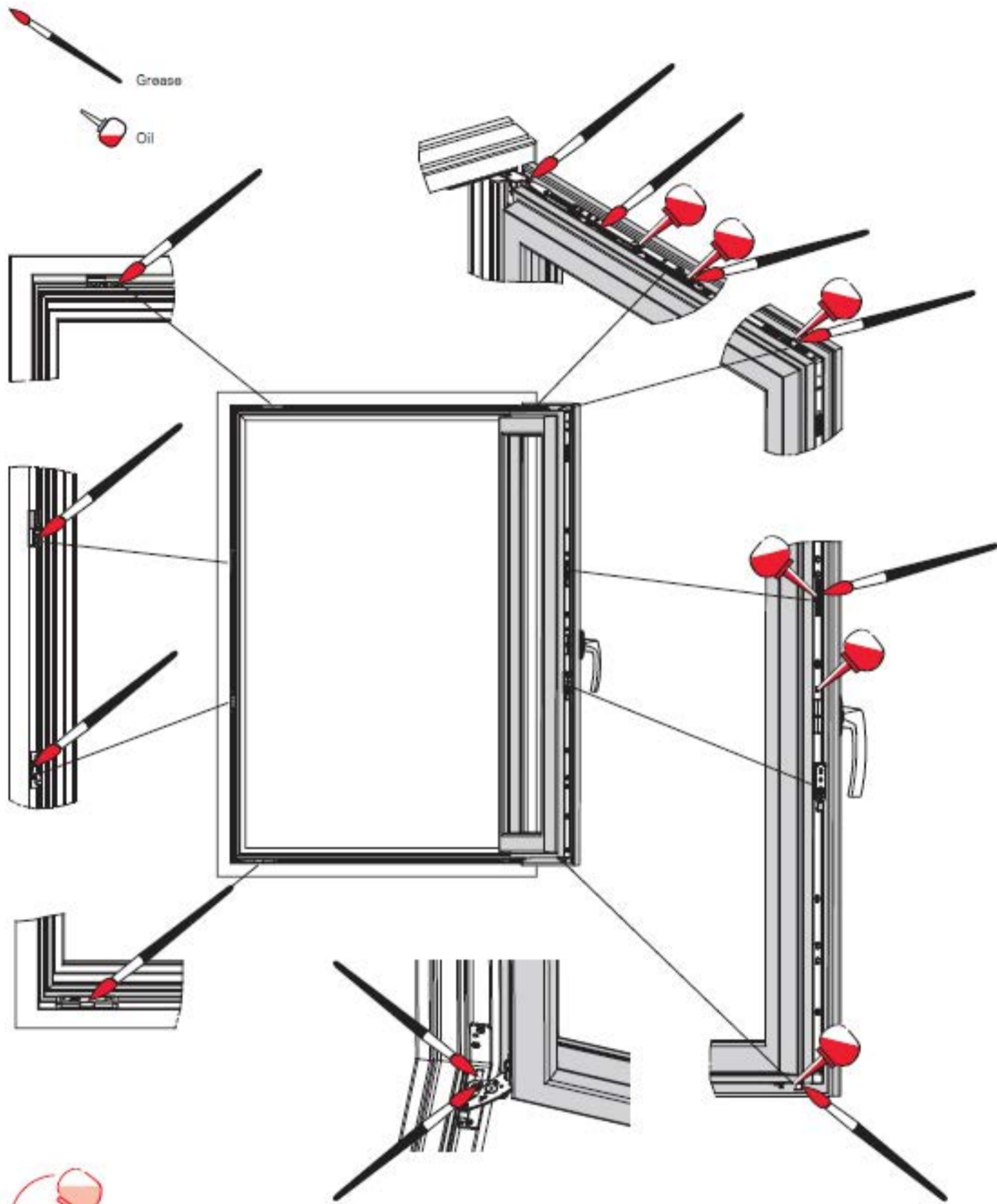

Maintenance



www.binq.com.au  
 info@binq.com.au  
 03 9773 2373  
 2-4 Ashley Park Drive,  
 Chelsea Heights 3196

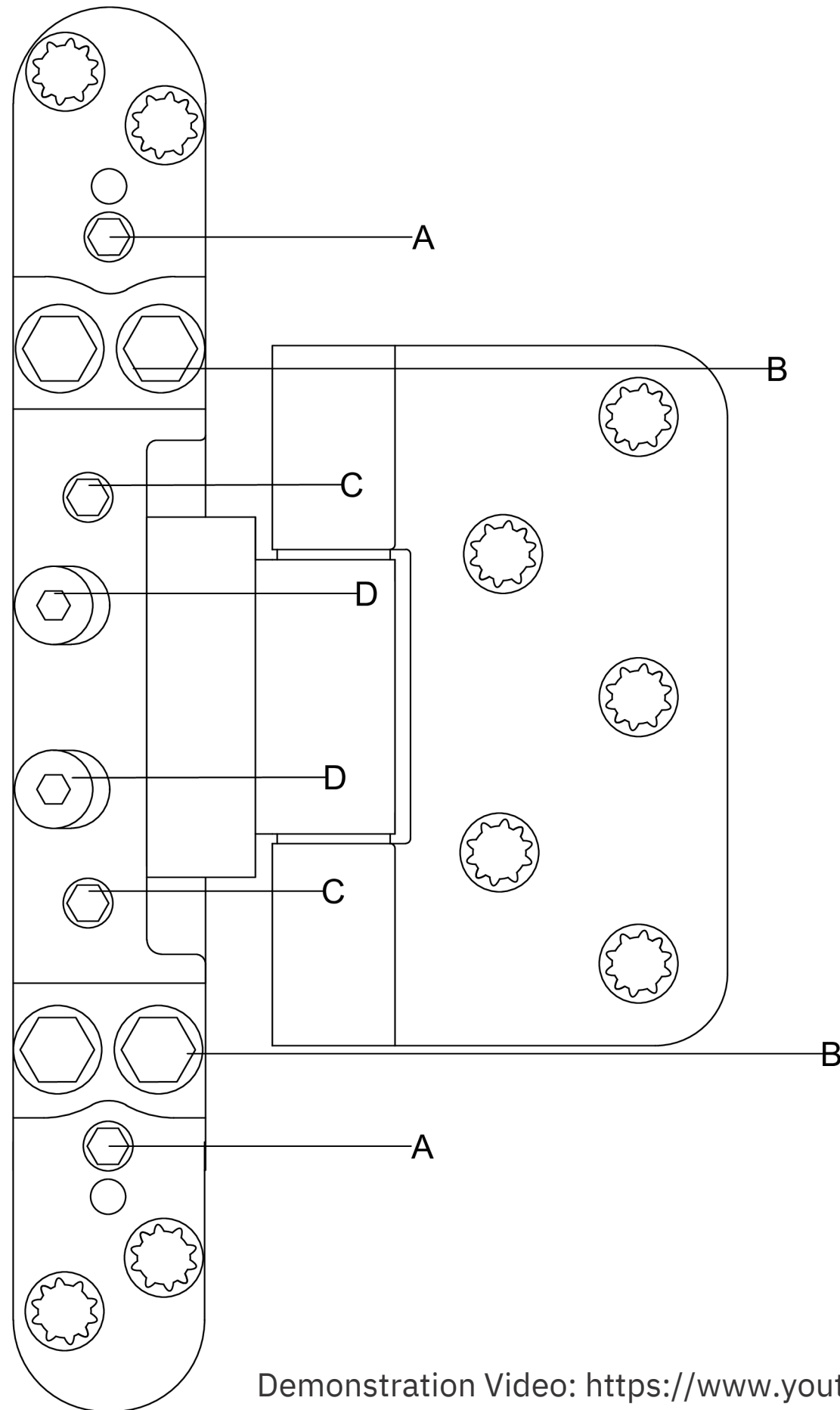

Demonstration Video: <https://www.youtube.com/watch?v=j-BfamNDvr8&t=18s>

## Adjustments:

### Vertical Adjustments



1. Loosen clamping screws (B) by 2 full rotations
2. To raise the height of the door, loosen the upper height adjustment screw (A) followed by tightening the lower height adjustment screw (A)
3. To lower the door, repeat step 2 in reverse
4. Retighten the clamping screws (B) when height is adjusted

### Horizontal Adjustments

1. Slightly loosen clamping screws (D)
2. Adjust the adjusting spindles (C) using a 4mm Allen Key
3. Twist right - towards hinge (max. 3mm)
4. Twist left - towards lock (max. 3mm)

### Seal Compression Adjustment

1. Slightly loosen the clamping screws (B and D) of each receiver
2. Adjust the door to the correct compression
3. Retighten clamping screws

Simonswerk Adjustable Hinge					REV
PART NO. VARIOUS	PROJECT				
DRAWN BY/DATE BG 19/10/2022	REFERENCE				
MATERIAL VARIES		SCALE @ A3 DNS	WEIGHT 1	<small>THIS DRAWING IS THE PROPERTY OF BINQ PTY LTD. INFORMATION CONTAINED HEREIN IS CONFIDENTIAL AND IT IS NOT TO BE USED NOR DISCLOSED TO 3RD PARTIES WITHOUT OUR WRITTEN PERMISSION.</small>	SHEET 1 / 1
FINISH/TREATMENT	<small>X ± 0.1 XX ± 0.01 ± 0.25</small>				

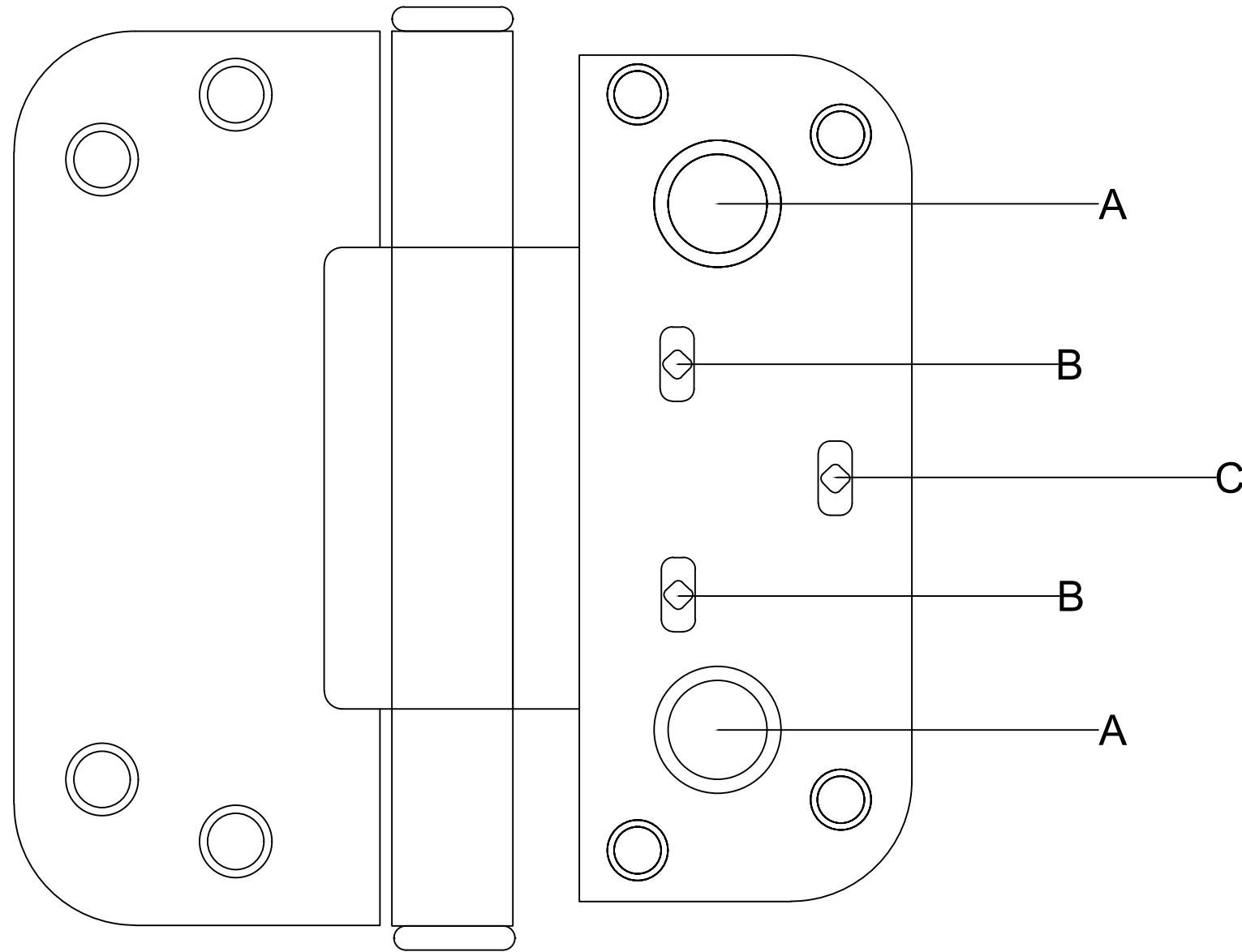

## Adjustments:

### Vertical Adjustments



1. Loosen screws (A) on hinges
2. Adjust door to desired height and tighten screws to secure.

### Horizontal Adjustments

1. Partially loosen screws (b) on hinge.
2. Turn screw (C) anti clockwise to move door panel away from jamb. Retighten (B) screws after adjustment.

### Seal Compression Adjustment

1. Loosen (B) screws.
2. Adjust door to correct compression on seal and retighten screws.

3D Adjustable Butt Hinge			www.binq.com.au	REV A
PART NO. VARIOUS	PROJECT			
DRAWN BY/DATE BG 17/10/2022	REFERENCE			
MATERIAL VARIES	 SCALE @ A3 DNS			
FINISH/TREATMENT	$\times \pm 0.1$ $\times X \pm 0.01$ $\pm 0.25^*$	WEIGHT 1	THIS DRAWING IS THE PROPERTY OF BINQ PTY LTD. INFORMATION CONTAINED HEREIN IS CONFIDENTIAL AND IT IS NOT TO BE USED NOR DISCLOSED TO 3RD PARTIES WITHOUT OUR WRITTEN PERMISSION	SHEET 1 / 1

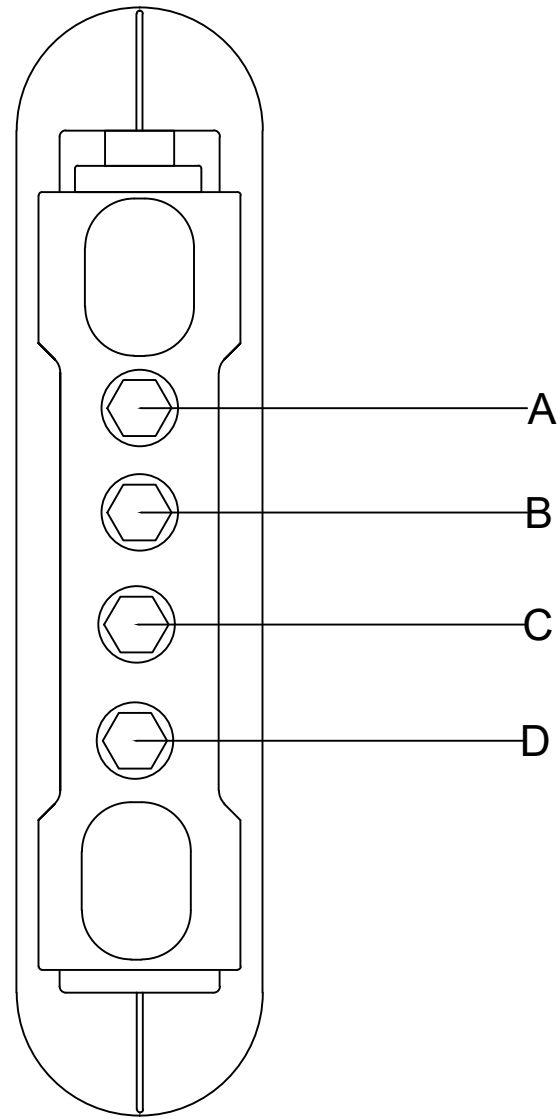

## Adjustments:

### Vertical Adjustments



1. Loosen clamp screw (B)
2. Loosen screw (D) to lower door to desired height
3. Tighten screw (D) to raise door to desired height
4. Tighten clamp screw (B) once door is at optimal height

### Horizontal Adjustments

1. Loosen clamp screw (B)
2. Loosen or tighten screw (A) to move door panel laterally left or right
3. Tighten clamp screw (B) once door is at optimal position

### Seal Compression Adjustment

1. Loosen clamp screw (B)
2. Loosen or tighten screw (C) to compress or decompress door panel against frame gaskets
3. Tighten clamp screw (B) once door is at optimal compression

IV68R Adjustable Hinge			www.binq.com.au	REV A
PART NO. VARIOUS	PROJECT			
DRAWN BY/DATE BG 19/10/2022	REFERENCE		SCALE @ A3 DNS	WEIGHT 1
MATERIAL VARIES	FINISH/TREATMENT			
<small>THIS DRAWING IS THE PROPERTY OF BINQ PTY LTD. INFORMATION CONTAINED HEREIN IS CONFIDENTIAL AND IT IS NOT TO BE USED NOR DISCLOSED TO 3RD PARTIES WITHOUT OUR WRITTEN PERMISSION.</small>		SHEET 1 / 1		

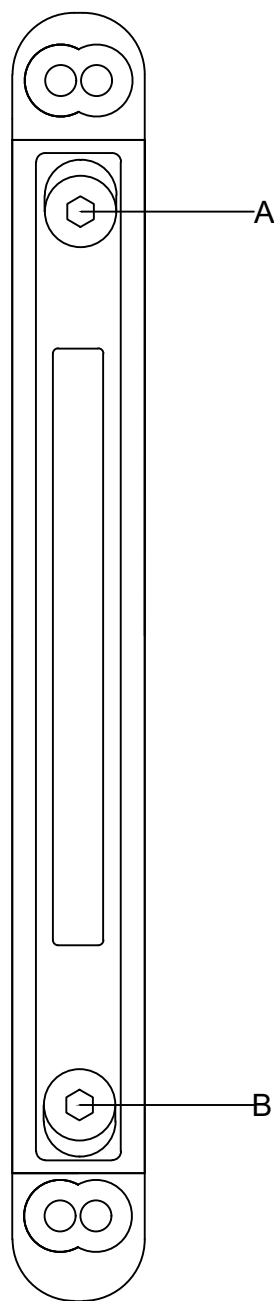

### Adjustments

#### Horizontal Adjustments

1. By rotating screw (A) clockwise, the top half of the strike plate will move towards the right (dependant on which side your door is hinged)
2. By rotating screw (B) anti-clockwise, the bottom half of the strike plate will move towards the right (dependant on which side your door is hinged)
3. Both screws (A & B) will need to be rotated in opposite directions to move the entire striker plate either left or right

AGB Strike			
PART NO. VARIOUS	PROJECT		
DRAWN BY/DATE BG 6/12/2022	REFERENCE		
MATERIAL VARIES	SCALE @ A3 DNS	www.binq.com.au	
FINISH/TREATMENT	WEIGHT 1	<small>THIS DRAWING IS THE PROPERTY OF BINQ PTY LTD. INFORMATION CONTAINED HEREIN IS CONFIDENTIAL AND IT IS NOT TO BE USED NOR DISCLOSED TO 3RD PARTIES WITHOUT OUR WRITTEN PERMISSION</small>	SHEET 1 / 1 REV A



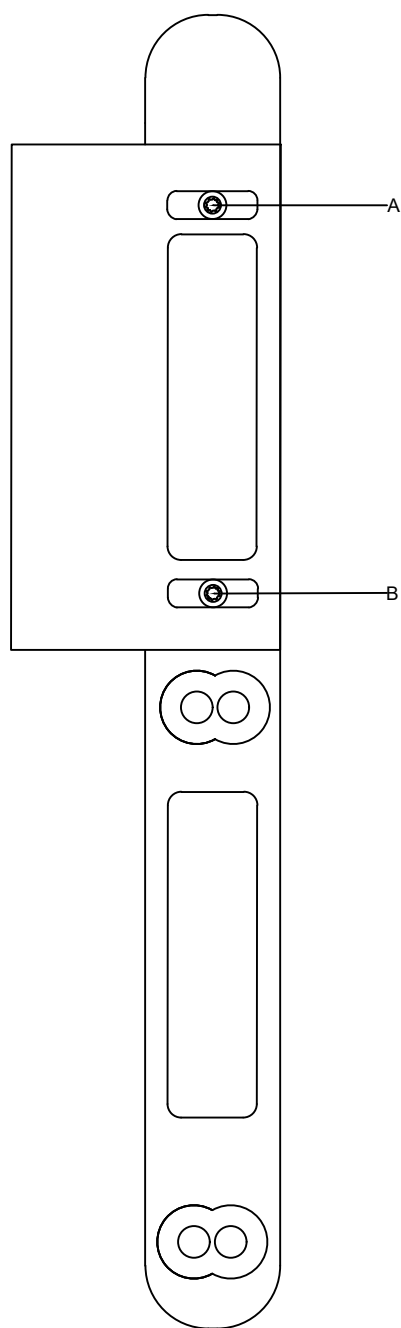

### Adjustments

#### Horizontal Adjustments

1. Loosen screws (A) and (B) with a 3mm Torx bit
2. Once screws have been loosened, striker plate can now adjusted from left to right as desired
3. Tighten screws (A) and (B) to secure striker plate into position

<b>AGB Multi Point Centre Lock</b>					REV
PART NO. VARIOUS	PROJECT				
DRAWN BY/DATE BG 6/12/2022	REFERENCE				
MATERIAL VARIES	SCALE @ A3 DNS	WEIGHT 1		www.binq.com.au	SHEET 1 / 1
FINISH/TREATMENT	$\times \pm 0.1$ $\times X \pm 0.01$ $\pm 0.25^*$	<small>THIS DRAWING IS THE PROPERTY OF BING PTY LTD.          INFORMATION CONTAINED HEREIN IS CONFIDENTIAL AND IT IS NOT TO BE          USED NOR DISCLOSED TO 3RD PARTIES WITHOUT OUR WRITTEN PERMISSION</small>		A	



[www.binq.com.au](http://www.binq.com.au)  
[info@binq.com.au](mailto:info@binq.com.au)  
03 9773 2373  
2-4 Ashley Park Drive,  
Chelsea Heights 3196